

15W/8424G00

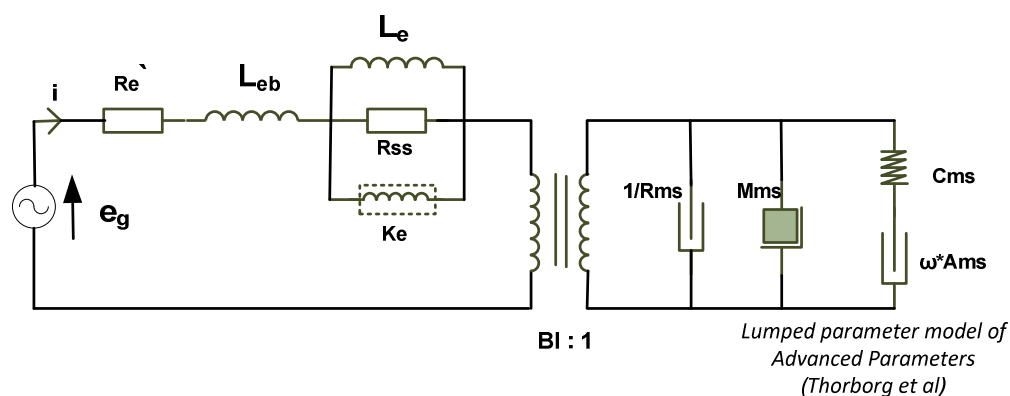

Electrical data

DC resistance ($R_{e'}$)	5.57	[Ω]
Free inductance (L_{eb})	0.074	[mH]
Bound inductance (L_e)	0.91	[mH]
Semi inductance (K_e)	0.088	SH
Shunt resistance (R_{ss})	249	[Ω]

Mechanical data

Force factor (BI)	6.40	[Tm]
Moving mass (M_{ms})	8.4	[g]
Compliance (C_{ms})	0.87	[mm/N]
Admittance (A_{ms})	0.13	[mm/N]
Mechanical resistance (R_{ms})	0.92	[Ns/m]