

18W/4424G00

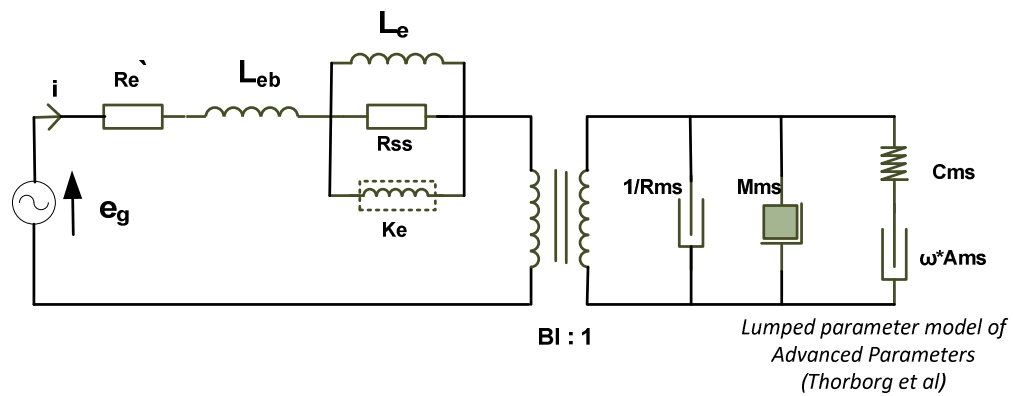

Electrical data

DC resistance ($R_{e'}$)	3.19	[Ω]
Free inductance (L_{eb})	0.040	[mH]
Bound inductance (L_e)	0.61	[mH]
Semi inductance (K_e)	0.061	SH
Shunt resistance (R_{ss})	208	[Ω]

Mechanical data

Force factor (BI)	5.19	[Tm]
Moving mass (M_{ms})	12.6	[g]
Compliance (C_{ms})	0.74	[mm/N]
Admittance (A_{ms})	0.10	[mm/N]
Mechanical resistance (R_{ms})	0.99	[Ns/m]