

18W/8434G00

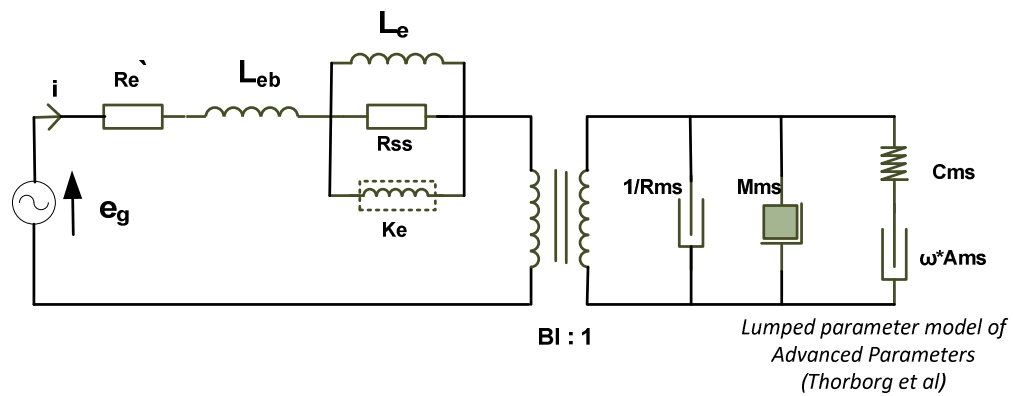

Electrical data

DC resistance ($R_{e'}$)	5.94	[Ω]
Free inductance (L_{eb})	0.153	[mH]
Bound inductance (L_e)	1.45	[mH]
Semi inductance (K_e)	0.049	SH
Shunt resistance (R_{ss})	250	[Ω]

Mechanical data

Force factor (BI)	6.82	[Tm]
Moving mass (M_{ms})	14.0	[g]
Compliance (C_{ms})	0.74	[mm/N]
Admittance (A_{ms})	0.06	[mm/N]
Mechanical resistance (R_{ms})	0.56	[Ns/m]