

25W/8565-00

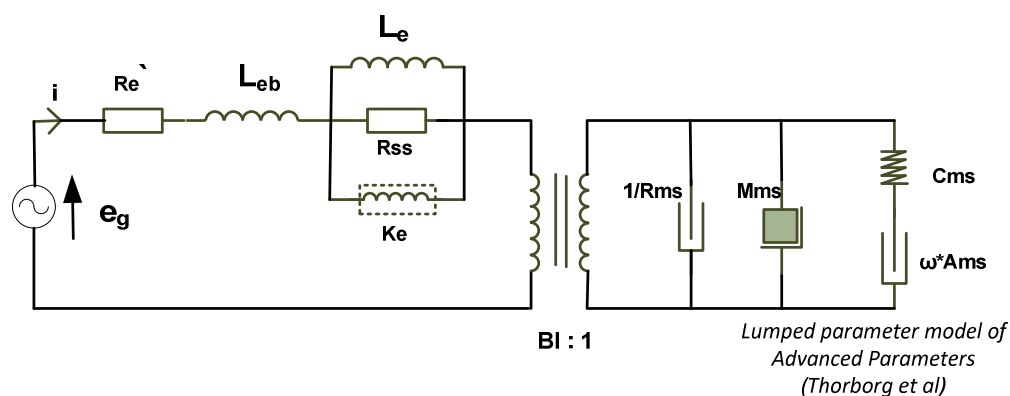

Electrical data

DC resistance ($R_{e'}$)	5.52	[Ω]
Free inductance (L_{eb})	0.159	[mH]
Bound inductance (L_e)	1.72	[mH]
Semi inductance (K_e)	0.030	SH
Shunt resistance (R_{ss})	125	[Ω]

Mechanical data

Force factor (BI)	7.75	[Tm]
Moving mass (M_{ms})	41.3	[g]
Compliance (C_{ms})	1.10	[mm/N]
Admittance (A_{ms})	0.11	[mm/N]
Mechanical resistance (R_{ms})	0.96	[Ns/m]