

26 cm Woofer

26W/4867T00

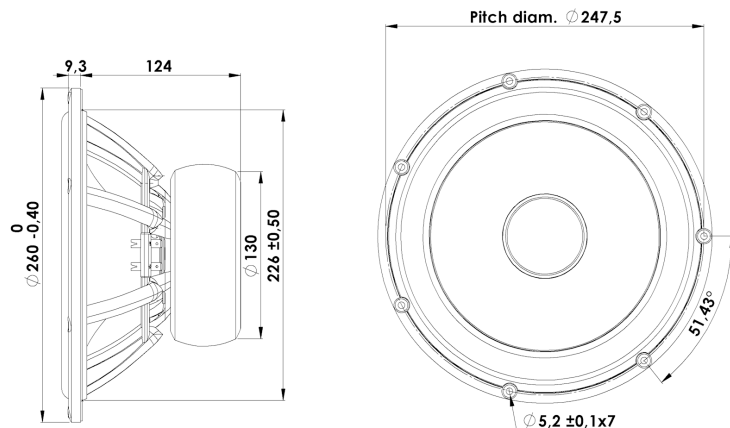

T-S Parameters:

Resonance frequency [fs]	18 Hz
Mechanical Q factor [Qms]	5.80
Electrical Q factor [Qes]	0.31
Total Q factor [Qts]	0.29
Force factor [Bl]	8.3 Tm
Mechanical resistance [Rms]	0.99 kg/s
Moving mass [Mms]	51 g
Compliance [Cms]	1.53 mm/N
Effective diaph. diameter [D]	202 mm
Effective piston area [Sd]	320 cm ²
Equivalent volume [Vas]	220 l
Sensitivity (2,83V/1m)	89 dB

Mechanical Data:

Voice coil diameter	50 mm
Voice coil height	24 mm
Voice coil layers	2
Gap height	6 mm
Linear excursion	± 9 mm
Max mech. excursion	± 14 mm
Unit weight	3.7 kg
Cabinet Displacement Volume	1.31 l

Electrical Data:

Nominal impedance [Zn]	4 Ω
Minimum impedance [Zmin]	4.4 Ω
Maximum impedance [Zo]	72.9 Ω
DC resistance [Re]	3.7 Ω
Voice coil inductance [Le]	0.25 mH

Power Handling:

100h RMS noise test (IEC 18.4)	80 W
Long-term max power (IEC 18.2)	200 W
X-over:	None

Key Features:

- Patented Symmetrical Drive Motor Design
- Rigid Black Anodized Alu Cone
- Low-Loss linear suspension
- Low Damping SBR Rubber Surround
- Die cast Alu Chassis vented below spider
- Ferrite Magnet System w. Rubber Boot

Recommendations (please see Tech Note):

- Operating frequency range: fs-1500 Hz
- Cabinet volume - closed box: Vbox=54 ltr, f(-3dB)=41 Hz
- Cabinet volume - vented box: Vbox=96 ltr, fb=23 Hz, f(-3dB)=26 Hz

